

POWERWARE 9155-S 8-10KVA SINGLE MODULE UPS

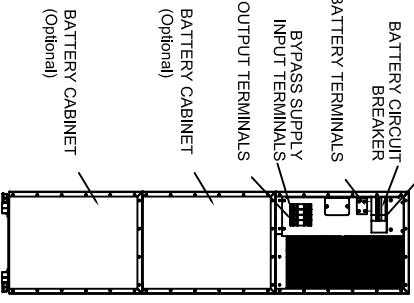
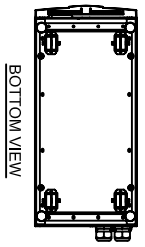
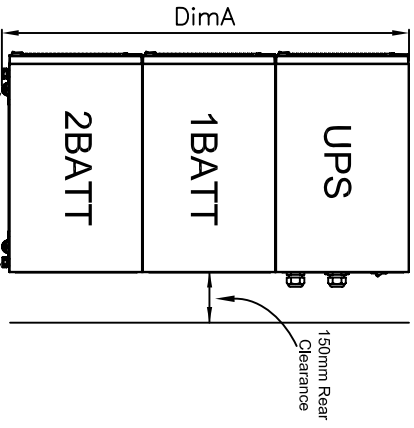
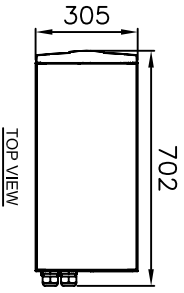
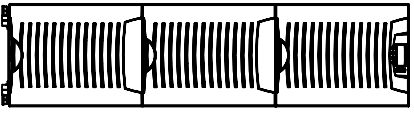
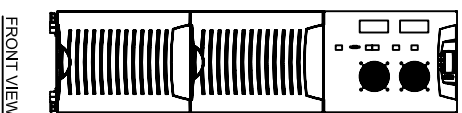
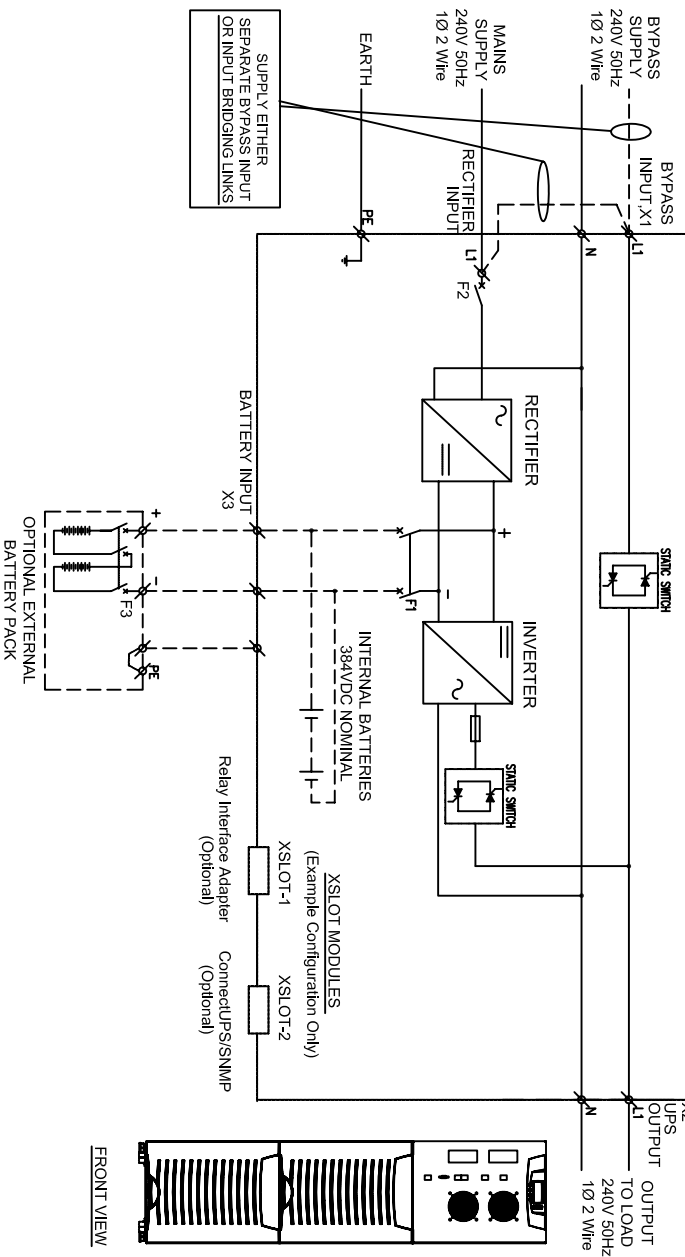

- Notes:
1. Wiring supplied by Eaton: External Battery Cabinet supplied with cables for connection to UPS
 2. Wiring supplied by others: Bypass Input (or Input Bridging Links), Mains Input & Load cables
 3. Battery Cable is sized to allow for side-by-side UPS & Battery Cabinets installation
 4. The system must be installed on a level floor suitable for electronic equipment.
 5. Ambient temperature range: 0-40°C; Recommended operating range: 20-25°C; Maximum relative humidity: 95% non-condensing.
 6. Minimum Clearances for ventilation & service around the UPS cabinet are:
Front, Side & Overhead of UPS: 0mm (no clearance required)
Rear of UPS: 150mm clearance required

7. For external MBS wiring, please refer to the appropriate wiring diagram that is supplied with MBS
8. All wiring and cabling is to be in accordance with National and Local Electrical Standards
9. Please also refer to appropriate battery cabinet site plan drawing
10. Optional External Batteries are available for extended runtimes (Internal batteries will not be installed if External Battery Cabinets are used)

Product Specifications

UPS Rating	Rated AC Input Voltage	Rated AC Output Voltage	Rectifier AC Input		Inverter AC Output Current	Max. Heat Dissipation at 100% Load	Dimensions WxDxH (see above for details)	Approx. Weight (No Batts)	Floor Loading	Airflow Req'ts	Maximum Cable Size			
			Continuous Current	Maximum							Input	Bypass	Output	Earth
kVA	kW	VAC	VAC	AMP	AMP	Watts	mm	kg	kg/m ²	litres/sec	sq.mm	sq.mm	sq.mm	sq.mm
8	7.2	240	240	34.8	40	768	305 x 702 x DimA	60	280	300	16	35	35	35
10	9	240	240	43.5	45	933	305 x 702 x DimA	60	280	300				

*Drawings and UPS Specifications are subject to change.

HEIGHT OF UPS (No Internal batteries)

UPS Part Number	DimA (mm)
9155-XX-4S00	420
9155-XX-4S0-1B, 9155-8-4S(L)14, 9155-10-4S(L)10	817
9155-XX-4S0-2B, 9155-8-4S(L)33, 9155-10-4S(L)25	1214



AS-1100
THIRD ANGLE PRODUCTION

UNLESS OTHERWISE SPECIFIED ALL DIMENSIONS IN MILLIMETERS.

DRAWING NUMBER	44SPG0001	REV	0
SITE PLANNING GUIDE		A4	
9155-S 8-10KVA UPS		A4SP0001Rev0.dwg	
SCALE	31:7.08	FILENAME	A4SP0001Rev0.dwg
DRAWN	GA	TITLE	SITE PLANNING GUIDE