

Powerware Series

Eaton® Rack Power Module
24–96A: 208Y/120V, 400Y/230V
User's Guide



Powering Business Worldwide

Powerware Series

Eaton® Rack Power Module
24–96A: 208Y/120V, 400Y/230V
User's Guide



Powering Business Worldwide

Requesting a Declaration of Conformity

Units that are labeled with a CE mark comply with the following harmonized standards and EU directives:

- Harmonized Standard: IEC 60950-1:2001
- EU Directives: 73/23/EEC, Council Directive on equipment designed for use within certain voltage limits
93/68/EEC, Amending Directive 73/23/EEC
89/336/EEC, Council Directive relating to electromagnetic compatibility
92/31/EEC, Amending Directive 89/336/EEC relating to EMC

The EC Declaration of Conformity is available upon request for products with a CE mark. For copies of the EC Declaration of Conformity, contact:

Eaton Power Quality Oy
Koskelontie 13
FIN-02920 Espoo
Finland
Phone: +358-9-452 661
Fax: +358-9-452 665 68

Eaton, Powerware, BladeUPS, Power Xpert, and X-Slot are registered trademarks of Eaton Corporation or its subsidiaries and affiliates. Modbus is a registered trademark of Schneider Electric. National Electrical Code and NEC are registered trademarks of National Fire Protection Association, Inc. All other trademarks are property of their respective companies.

©Copyright 2007–2010 Eaton Corporation, Raleigh, NC, USA. All rights reserved. No part of this document may be reproduced in any way without the express written approval of Eaton Corporation.

Special Symbols

The following are examples of symbols used on the UPS or accessories to alert you to important information:



RISK OF ELECTRIC SHOCK - Indicates that a risk of electric shock is present and the associated warning should be observed.



CAUTION: REFER TO OPERATOR'S MANUAL - Refer to your operator's manual for additional information, such as important operating and maintenance instructions.



This symbol indicates that you should not discard waste electrical or electronic equipment (WEEE) in the trash. For proper disposal, contact your local recycling/reuse or hazardous waste center.

Table of Contents

1	Introduction	9
	Safety Warnings	11
2	Installation	15
	Inspecting the Equipment	15
	Tools Required	15
	Checking the Accessory Kit	16
	Cable Tray Installation (Optional)	17
	Wallmount Installation	18
	Rack Installation	20
	Plug-Receptacle Installation	23
	Hardwired Installation	24
	Advanced Metering Installation (Optional)	28
3	Operation	29
	Introduction	29
	Breakers	30
	Color-Coded Numbering	30
	LED Display	31
	Alarm and Power Indicators	32
	TVSS Indicator	32
	Service Only Port and Switches	32
4	Specifications	33
5	Troubleshooting	39
	Typical Alarms and Conditions	39
	Service and Support	40
6	Warranty	41
	Limited Factory Warranty	41

TABLE OF CONTENTS

Chapter 1 Introduction

The Eaton® Rack Power Module (RPM-3U/3Ui) is designed to distribute power within a rack. Providing outstanding performance and reliability, the RPM-3U/3Ui's unique benefits include the following:

- Provides plug-and-play primary distribution from a three-phase UPS to secondary power distribution devices. The RPM-3U/3Ui is ideal for enhancing the output distribution of UPSs such as the Eaton BladeUPS®.
- Functions in a wide variety of applications supporting various data center loads at various voltages, power cord configurations, and layouts.
- Can be installed in any standard 48-cm (19-inch) EIA rack or cabinet in 3U applications with included hardware.
- Can be mounted on a wall with the optional wallmount brackets and customer-provided fasteners appropriate for the type of wall.
- Organizes power distribution and simplifies cable management, making it easier to follow the power path to the load. The RPM-3U/3Ui also improves load balancing, reducing nuisance overload alarms from the UPS.
- Indicator LEDs that show when incoming power is available to the RPM-3U/3Ui and when an alarm is present.
- Columns of LEDs labeled to match the output breaker poles and the input lines. Each column displays a reading of load status.
- Circuit breakers and indicator LEDs located on the front panel for easy access.
- Plug-receptacle model that is customer-installable without the services of a licensed electrician, once the main connection to the UPS is made.
- Backed by worldwide agency approvals.

The following options for the RPM-3U/3Ui are available:

- Choice of input power cord lengths:
 - 1.8m (6 ft)
 - 3.0m (10 ft)
 - 4.6m (15 ft)
 - 6.1m (20 ft)
- Multiple input options:
 - BladeUPS connector (208Y/120V or 400Y/230V)
 - IEC 309-60A
 - L21-30P
 - Hardwired (208Y/120V or 400Y/230V)
- Multiple output receptacle options:
 - IEC 320-C13, IEC 320-C19
 - 5-15R, 5-20R
 - L6-15R, L6-20R, L6-30R
 - L14-20R, L14-30R
 - L15-20R, L15-30R
 - L21-20R, L21-30R
- Surge protection with the optional Transient Voltage Surge Suppression (TVSS) card.
- Advancing Metering with the Universal Control Board (UCB) and Power Xpert® Gateway Series 1000 Card.

The RPM-3U/3Ui allows configurations such as:

- Converting three-phase inputs to single-phase outputs to connect to single-phase rack outlet strips.
- Incorporating three-way splitter cables to split three-phase receptacle voltage into 3x single-phase receptacles, allowing a single three-phase receptacle to feed three racks, each containing conventional single-phase strips with outlets. Such a configuration could support a minimum of two high-density racks or a maximum of nine low-density (approximately 2 kVA) racks.

Safety Warnings

IMPORTANT SAFETY INSTRUCTIONS SAVE THESE INSTRUCTIONS

This manual contains important instructions that you should follow during installation and operation of the RPM-3U/3Ui. Please read all instructions before operating the equipment and save this manual for future reference.

DANGER



This RPM-3U/3Ui contains **LETHAL VOLTAGES**. All repairs and service should be performed by **AUTHORIZED SERVICE PERSONNEL ONLY**. There are **NO USER SERVICEABLE PARTS** inside the RPM-3U/3Ui.

CAUTION



- To reduce the risk of fire or electric shock, install this RPM-3U/3Ui in a temperature and humidity controlled, indoor environment, free of conductive contaminants. Ambient temperature must not exceed 30°C (86°F). Do not operate near water or excessive humidity (95% maximum).
 - To comply with international standards and wiring regulations, the total equipment connected to the output of this RPM-3U/3Ui must not have an earth leakage current greater than 3.5 milliamperes.
 - For **PERMANENTLY CONNECTED EQUIPMENT**, a readily accessible disconnect device shall be incorporated in the building installation wiring.
 - For **PLUGGABLE EQUIPMENT**, the power outlet shall be installed near the equipment and shall be readily accessible.
-

Consignes de sécurité

CONSIGNES DE SÉCURITÉ IMPORTANTES CONSERVER CES INSTRUCTIONS

Ce manuel contient des instructions importantes que vous êtes invité à suivre lors de toute procédure d'installation et de fonctionnement de RPM-3U/3Ui. Veuillez consulter entièrement ces instructions avant de faire fonctionner l'équipement et conserver ce manuel afin de pouvoir vous y reporter ultérieurement.



DANGER!

Cet RPM-3U/3Ui contient des TENSIONS MORTELLES. Toute opération d'entretien et de réparation doit être **EXCLUSIVEMENT CONFIEE A UN PERSONNEL QUALIFIE AGRÉÉ**. **AUCUNE PIÈCE RÉPARABLE PAR L'UTILISATEUR** ne se trouve dans la RPM-3U/3Ui.



ATTENTION!

- Pour réduire les risques d'incendie et de décharge électrique, installer la RPM-3U/3Ui uniquement à l'intérieur, dans un lieu dépourvu de matériaux conducteurs, où la température et l'humidité ambiantes sont contrôlées. La température ambiante ne doit pas dépasser 30 °C. Ne pas utiliser à proximité d'eau ou dans une atmosphère excessivement humide (95 % maximum).
- Afin d'être conforme aux normes et règlements internationaux de câblage, le courant de fuite à la terre de la totalité du matériel branché sur la sortie de la RPM-3U/3Ui ne doit pas dépasser 3,5 mA.
- Afin de **CONNECTER DE MANIÈRE PERMANENTE L'ÉQUIPEMENT**, un dispositif de déconnexion aisément accessible doit être incorporé au câblage d'installation du bâtiment.
- En ce qui concerne l'**ÉQUIPEMENT ENFICHABLE**, la prise d'alimentation doit être installée près de l'équipement et doit être facile d'accès.

Sicherheitswarnungen

WICHTIGE SICHERHEITSANWEISUNGEN AUFBEWAREN

Dieses Handbuch enthält wichtige Hinweise, welche Sie bei der Installation und Wartung des RPM-3U/3Ui beachten sollten. Bitte lesen Sie alle Anweisungen des Handbuches bevor sie mit dem Gerät arbeiten. Bewahren Sie das Handbuch zum Nachlesen auf.

WARNUNG



Die RPM-3U/3Ui führt lebensgefährliche Spannungen. Alle Reparatur- und Wartungsarbeiten sollten nur von Kundendienstfachleuten durchgeführt werden. Die RPM-3U/3Ui enthält keine vom Benutzer zu wartenden Komponenten.

ACHTUNG



- Um die Brand- oder Elektroschockgefahr zu verringern, diese RPM-3U/3Ui nur in Gebäuden mit kontrollierter Temperatur und Luftfeuchtigkeit installieren, in denen keine leitenden Schmutzstoffen vorhanden sind. Die Umgebungstemperatur darf 30°C nicht übersteigen. Die RPM-3U/3Ui nicht in der Nähe von Wasser oder in extrem hoher Luftfeuchtigkeit (max. 95 %) betreiben.
 - Um internationale Normen und Verdrahtungsvorschriften zu erfüllen, dürfen die an den Ausgang dieser RPM-3U/3Ui angeschlossenen Geräte zusammen einen Erdableitstrom von insgesamt 3,5 Milliampere nicht überschreiten.
 - Für PERMANENT ANGESCHLOSSENE GERÄTE: In der Gebäudeverkabelung muss eine leicht zugängliche Trennvorrichtung enthalten sein.
 - Für GERÄTE MIT STECKERN: Die Steckdose muss sich in der Nähe des Geräts befinden und leicht zugänglich sein.
-

Advertencias de Seguridad

INSTRUCCIONES DE SEGURIDAD IMPORTANTES GUARDE ESTAS INSTRUCCIONES

Este manual contiene instrucciones importantes que debe seguir durante la instalación y el funcionamiento de la RPM-3U/3Ui. Por favor, lea todas las instrucciones antes de poner en funcionamiento el equipo y guarde este manual para referencia en el futuro.



PELIGRO

Este RPM-3U/3Ui contiene VOLTAJES MORTALES. Todas las reparaciones y el servicio técnico deben ser efectuados **SOLAMENTE POR PERSONAL DE SERVICIO TÉCNICO AUTORIZADO**. No hay **NINGUNA PARTE QUE EL USUARIO PUEDA REPARAR** dentro de la RPM-3U/3Ui.



PRECAUCIÓN

- Para reducir el riesgo de incendio o de choque eléctrico, instale este RPM-3U/3Ui en un lugar cubierto, con temperatura y humedad controladas, libre de contaminantes conductores. La temperatura ambiente no debe exceder los 30°C. No trabaje cerca del agua o con humedad excesiva (95% máximo).
 - Para cumplir con los estándares internacionales y las normas de instalación, la totalidad de los equipos conectados a la salida de este RPM-3U/3Ui no debe tener una intensidad de pérdida a tierra superior a los 3,5 miliamperios.
 - Para **EQUIPO CONECTADO PERMANENTEMENTE**, se debe incorporar un dispositivo de desconexión fácilmente accesible al cableado de la instalación del edificio.
 - Para **EQUIPO ENCHUFABLE**, la salida de alimentación debe estar instalada cerca del equipo y estar fácilmente accesible.
-

Chapter 2 Installation

This section explains:

- Equipment inspection
- Rack Power Module (RPM-3U/3Ui) setup and installation

Inspecting the Equipment

If any equipment has been damaged during shipment, keep the shipping cartons and packing materials for the carrier or place of purchase and file a claim for shipping damage. If you discover damage after acceptance, file a claim for concealed damage.

To file a claim for shipping damage or concealed damage: 1) File with the carrier within 15 days of receipt of the equipment; 2) Send a copy of the damage claim within 15 days to your service representative.

Tools Required

To assemble the components, the following tools may be needed:

- #2 Phillips screwdriver
- 5/16" nut driver or socket and wrench

For a hardwired installation, the following additional tools may be needed:

- #2 flat-bladed screwdriver
- #1 Phillips screwdriver
- 10 mm nut driver or socket and wrench

Checking the Accessory Kit

Verify that the following items are included with the RPM-3U/3Ui.

Rail kit items:

- (2) front mounting brackets
- (8) M4 flat-head screws, plus (2) extra
- (2) rail assemblies (left and right)
- (2) hold-down brackets
- (6) wing nuts, (6) flat washers, and (6) split lock washers (already installed on the rail assemblies and hold-down brackets)
- (12) #10-32 hex-head screws
- (4) #10-32 clip nuts

Other items:

- (1) cable tray
- (12) cable ties
- (1) set of cable labels
- This user's guide

If you ordered the wallmount option:

- (2) wallmount brackets
- (4) M4 flat-head screws
- (8) M4 pan-head screws

If you ordered the Advanced Metering option:

- Power Xpert Gateway Series 1000 Card (installed in the RPM-3U/3Ui)
- Configuration (serial) cable
- Ethernet cable
- Power Xpert Gateway Series 1000 Card registration card
- *Power Xpert Gateway Series 1000 Card Quick Start Instructions*



NOTE For more detailed information, download the Power Xpert Gateway Series 1000 Card User's Guide from the Documentation page on the Power Xpert card once the card is accessible on the user's network or from www.eaton.com/powerxpert.

Cable Tray Installation (Optional)



NOTE Follow these instructions only if you are installing an optional cable tray on an RPM-3U/3Ui that will be installed in a rack. If you are mounting the RPM-3U/3Ui on a wall, install the cable tray as part of the wallmount installation. See the following section, “Wallmount Installation.”

To install the cable tray on an RPM-3U/3Ui that will be installed in a rack:

1. Align the cable tray with the screw holes on the sides of the RPM-3U/3Ui as shown in Figure 1.
2. Secure the cable tray with the supplied four M4 flat-head screws.
3. Continue to “Rack Installation” on page 20.

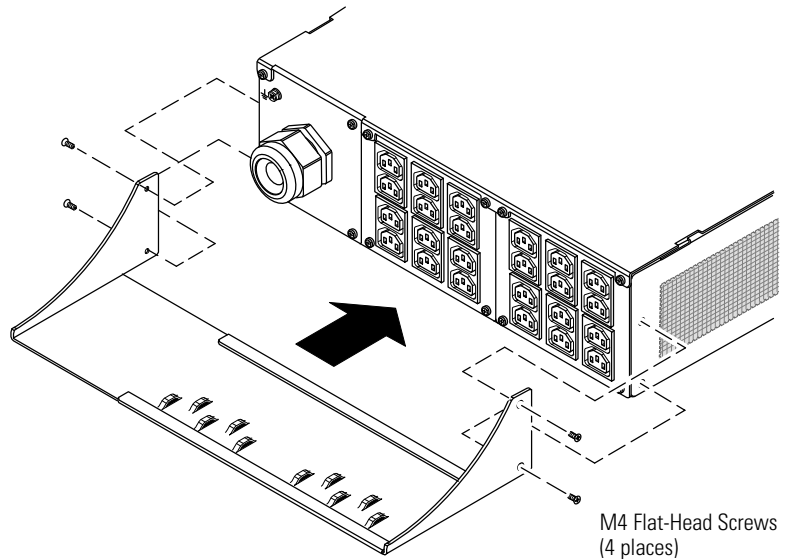

Figure 1. Installing the Cable Tray (Plug-Receptacle Unit Shown)

Wallmount Installation

To install the RPM-3U/3Ui on a wall:

1. Obtain the appropriate number and type of mounting fasteners for the type of wall and the weight of the RPM-3U/3Ui, any installed options, and power cords. This hardware is not included with the RPM-3U/3Ui. See “Specifications” on page 33 for weights.
2. Locate an area on the wall suitable for mounting the RPM-3U/3Ui. See Figure 2 to mark the locations on the wall for the customer-supplied mounting fasteners.



NOTE The wallmount brackets and the RPM-3U/3Ui must be installed so that the breakers face LEFT or RIGHT. For proper functioning, the breakers must NOT face up or down.

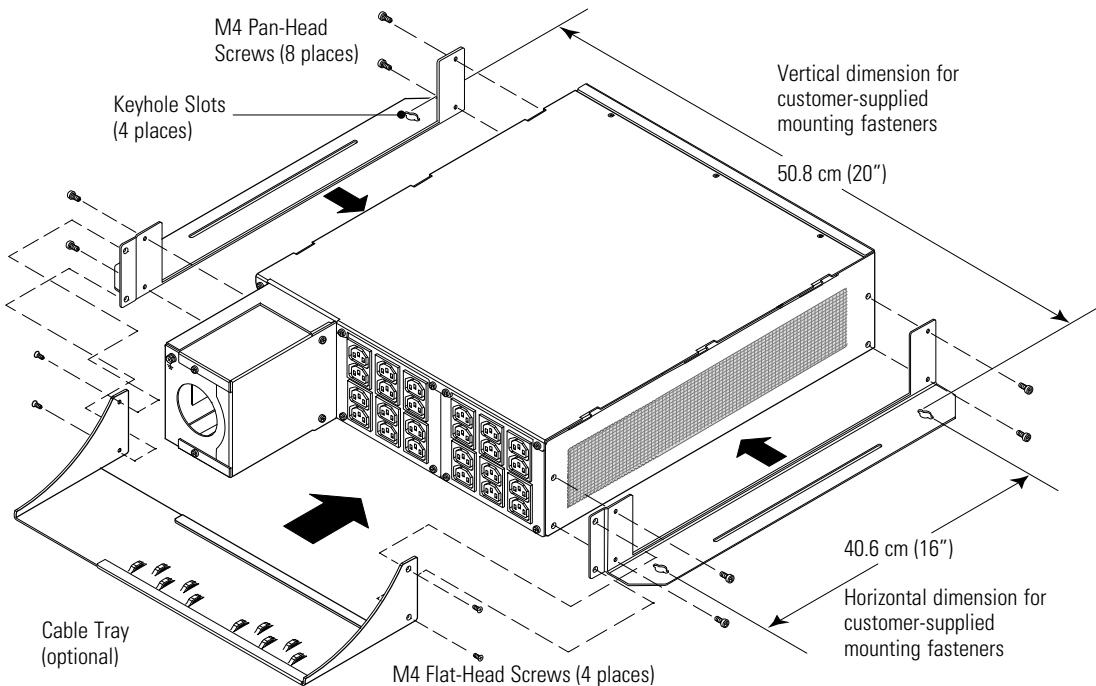

Figure 2. Wallmount Installation (Hardwired Unit Shown)

3. Secure the two wallmount brackets to the RPM-3U/3Ui with the supplied eight M4 pan-head screws (see Figure 2).
4. (Optional) Secure the cable tray to the wallmount brackets with the supplied four M4 flat-head screws (see Figure 2).
5. Install two customer-supplied mounting fasteners for the top keyhole slots into the wall (do not tighten).
6. Place the RPM-3U/3Ui on the wall, and adjust the placement so that the fasteners mounted on the wall move into the small ends of the keyhole slots.

Verify the RPM-3U/3Ui is firmly flush against the wall, then tighten the two mounting fasteners.

7. Secure the RPM-3U/3Ui to the wall with the remaining customer-supplied mounting fasteners.

Verify that the number and type of mounting fasteners are appropriate for the type of wall and the weight of the RPM-3U/3Ui, any installed options, and power cords. See "Specifications" on page 33 for weights.

8. Continue to one of the RPM-3U/3Ui installation sections:
 - "Plug-Receptacle Installation" on page 23.
 - "Hardwired Installation" on page 24.

Rack Installation



NOTE Access to the front, rear, and both sides of the rack is required to install the RPM-3U/3Ui in the rack.

To install the RPM-3U/3Ui in a rack:

1. Align the front mounting brackets with the screw holes on the sides of the RPM-3U/3Ui as shown in Figure 3.
2. Secure the brackets with the supplied four M4 flat-head screws.

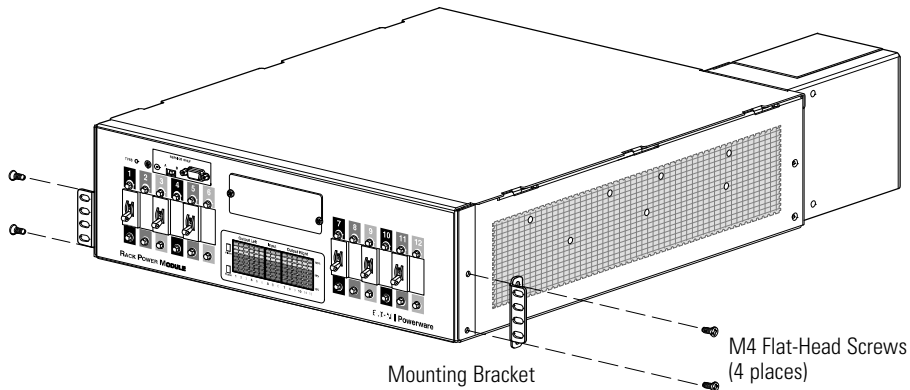

Figure 3. Installing the Front Mounting Brackets (Hardwired Unit Shown)

3. Loosen the wing nuts on both rail assemblies and adjust the rail size for the depth of your rack.
4. Use the supplied hardware to secure one rail assembly to the rack as shown in Figure 4:

Using two screws, attach the rail to the front of the rack. Use the top and bottom hole locations on the front of the rail.

Using two clip nuts and two screws, attach the rail to the rear of the rack. Attach the clip nuts to the edge of the rack upright, then insert the screws.

5. Repeat Step 4 for the other rail.
6. Tighten the wing nuts on both rail assemblies.

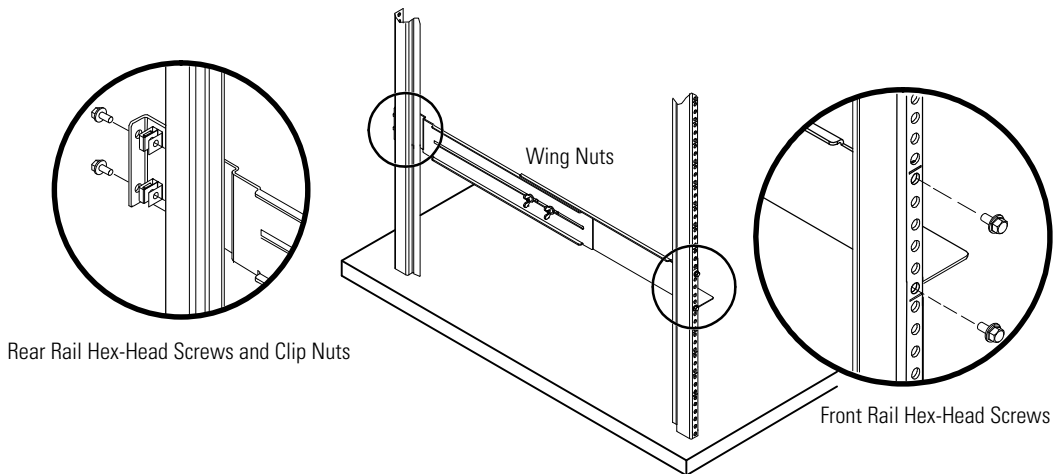

Figure 4. Securing the Front and Rear of Rails (Left Rail on Typical Rack Shown)

7. Attach a rear hold-down bracket to each rail (see Figure 5):
 Insert the bracket's stud through the rail slot. Fasten loosely with two washers and a wing nut. Tabs on the bracket keep the bracket upright until secured.
8. Slide the RPM-3U/3Ui into the rack.
9. Secure the front of the RPM-3U/3Ui to the rack with the supplied screws (see Figure 5).
10. Loosen the wing nut on each rear hold-down bracket so that the bracket slides easily in the rail. Align the edge of each bracket with the rear edge of the RPM-3U/3Ui as shown in Figure 5.

Verify that the brackets are seated firmly, then tighten the wing nuts. The RPM-3U/3Ui is now secured in the rack.

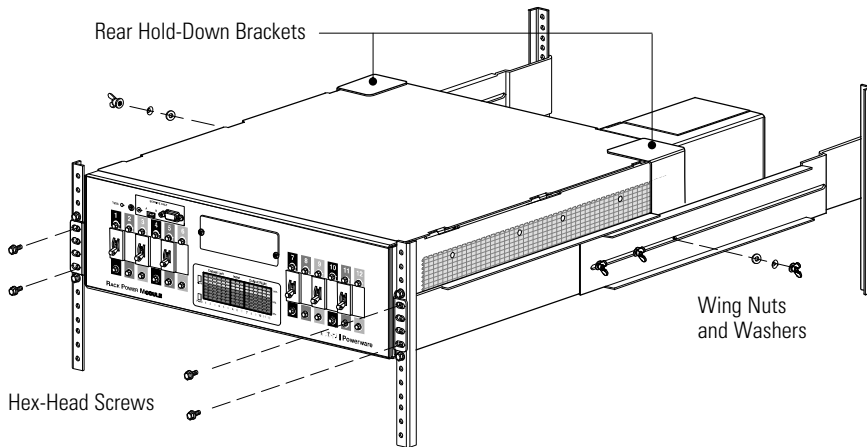

Figure 5. Attaching the RPM-3U/3Ui to the Rack (Hardwired Unit Shown)

11. Continue to one of the RPM-3U/3Ui installation sections:
 - “Plug-Receptacle Installation” on page 23.
 - “Hardwired Installation” on page 24.

Plug-Receptacle Installation



CAUTION

To prevent mechanical damage, coil and secure any excess cable away from the floor.

To install the plug-receptacle RPM-3U/3Ui:

1. Verify that the RPM-3U/3Ui is properly installed in the rack or wallmount brackets and that each circuit breaker on the RPM-3U/3Ui front panel is in the OFF (O) position. The Power indicator should be off.
2. If your rack has conductors for grounding or bonding of ungrounded metal parts, connect the ground cable (not included) to the ground bonding screw on the RPM-3U/3Ui rear panel. Figure 6 shows the location of the ground bonding screw.
3. Plug the equipment power cords into the RPM-3U/3Ui output receptacles.



NOTE The RPM-3U/3Ui receptacles are protected separately by each circuit breaker on the front panel.

NOTE Confirm that the equipment connected to the RPM-3U/3Ui does not exceed the RPM-3U/3Ui's capacity. See "Specifications" on page 33 for the maximum rating for each receptacle.

(Optional) Use the supplied labels to mark the equipment loads.

4. Plug the RPM-3U/3Ui input power cord into the UPS. Power on the UPS if not already on.

The Power indicator on the RPM-3U/3Ui illuminates.

Verify that the Alarm indicator is off. If the Alarm indicator is illuminated, see "Alarm and Power Indicators" on page 32.

5. Make provision for any required cord retention or strain relief.
6. For each receptacle to be monitored, turn its circuit breaker on the RPM-3U/3Ui front panel to the ON (|) position.



NOTE If power to the RPM-3U/3Ui is interrupted, check each circuit breaker and reset if necessary.

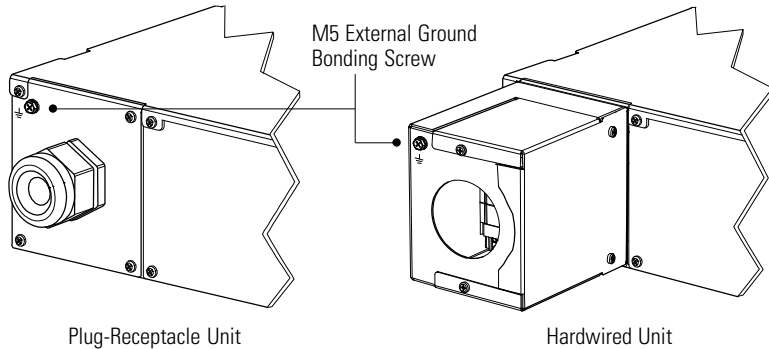

Figure 6. Ground Bonding Screw

Hardwired Installation

WARNING



Only qualified service personnel (such as a licensed electrician) shall perform the electrical installation. Risk of electrical shock.

CAUTION



- For PERMANENTLY CONNECTED EQUIPMENT, a readily accessible disconnect device shall be incorporated in the building installation wiring.
- To prevent mechanical damage, coil and secure any excess cable away from the floor.
- Hardwired units require a customer-supplied 125A upstream circuit breaker with 35 mm² (1 AWG) wiring rated minimum 90°C. Consult local electrical codes for other wire and circuit breaker rating options.

To hardwire the RPM-3U/3Ui:

1. Verify that the RPM-3U/3Ui is properly installed in the rack or wallmount brackets and that each circuit breaker on the RPM-3U/3Ui front panel is in the OFF (O) position. The Power indicator should be off.
2. If your rack has conductors for grounding or bonding of ungrounded metal parts, connect the ground cable (not included) to the ground bonding screw on the RPM-3U/3Ui rear panel. Figure 6 shows the location of the ground bonding screw.

3. Switch off utility power at the distribution point where the RPM-3U/3Ui will be connected. Be absolutely sure there is no power.
4. Use a Phillips screwdriver to remove the four screws from the input box access cover and retain (see Figure 7).
5. Slide the access cover off the input box and retain.

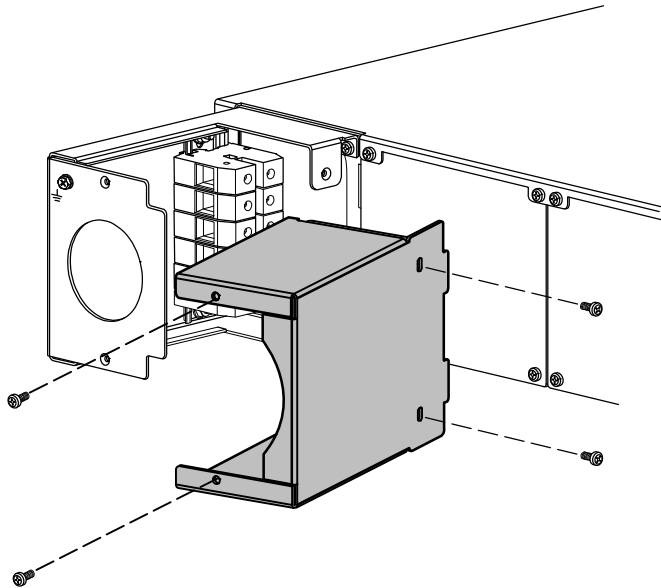

Figure 7. Removing the Input Box Access Cover



NOTE The pre-punched wiring access entry accepts a 5.08 cm (2") inner diameter bushing.

6. Pull the input wires through conduit, leaving approximately 15 cm (6") of exposed wire. Attach a polyvinyl chloride (PVC) fitting to the end of the conduit.
7. Insert the fitting through the wiring access entry and secure with a locking nut. Strip 1.5 cm (0.5") of insulation from the end of each incoming wire.

8. Connect the input wires to the input terminal block according to Figure 8 and Table 1.

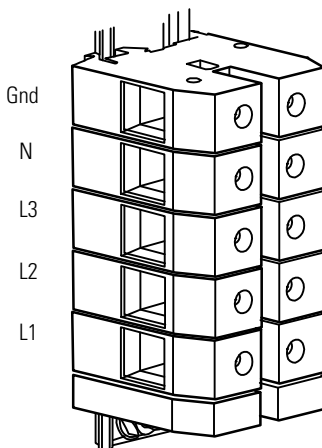

Figure 8. RPM-3U/3Ui Terminal Block

Table 1. RPM-3U/3Ui Wiring Specifications

PDU Wire Function	Terminal Position	Terminal Wire Size Rating*	Tightening Torque
Ground	Gnd		
Neutral	N		
Phase 3	L3	35 mm ² (1 AWG)	NOTE Refer to label on terminal block.
Phase 2	L2		
Phase 1	L1		

* Use 90°C copper wire minimum. Suggested wire size is based on full input current rating applied to National Electrical Code® (NEC®) Table 310.16 for four (4) current carrying conductors in conduit.

9. Replace the input box access cover and secure with the four screws removed in Step 4.

10. Plug the equipment power cords into the RPM-3U/3Ui output receptacles.



NOTE The RPM-3U/3Ui receptacles are protected separately by each circuit breaker on the front panel.

NOTE Confirm that the equipment connected to the RPM-3U/3Ui does not exceed the RPM-3U/3Ui's capacity. See "Specifications" on page 33 for the maximum rating for each receptacle.

(Optional) Use the supplied labels to mark the equipment loads.

11. Turn on utility power where the RPM-3U/3Ui is connected.

The Power indicator on the RPM-3U/3Ui illuminates.

Verify that the Alarm indicator is off. If the Alarm indicator is illuminated, see "Alarm and Power Indicators" on page 32.

12. Make provision for any required cord retention or strain relief.

13. For each receptacle to be monitored, turn its circuit breaker on the RPM-3U/3Ui front panel to the ON (|) position.



NOTE If power to the RPM-3U/3Ui is interrupted, check each circuit breaker and reset if necessary.

Advanced Metering Installation (Optional)



NOTE Follow these instructions only if you ordered the Advanced Metering option.

The Power Xpert Gateway Series 1000 Card (shown in Figure 9) is factory-installed in the X-Slot® communication bay on the front of the RPM-3U/3Ui. See Figure 11 on page 30 for the location of the communication bay.

To connect the cables and configure the card:

1. Locate the *Power Xpert Gateway Series 1000 Card Quick Start Instructions* included with the RPM-3U/3Ui.
2. Perform all the steps in the quick start instructions, ignoring the initial few steps that describe how to install the card in a PDU.

The quick start instructions direct you to:

- Connect the Ethernet cable
 - Connect the configuration (serial) cable
 - Configure IP Address assignments
3. For more detailed information about installing the card or using Advanced Metering, download the Power Xpert Gateway Series 1000 Card user's guide from the Documentation page on the Power Xpert card once the card is accessible on your network or from www.eaton.com/powerxpert.

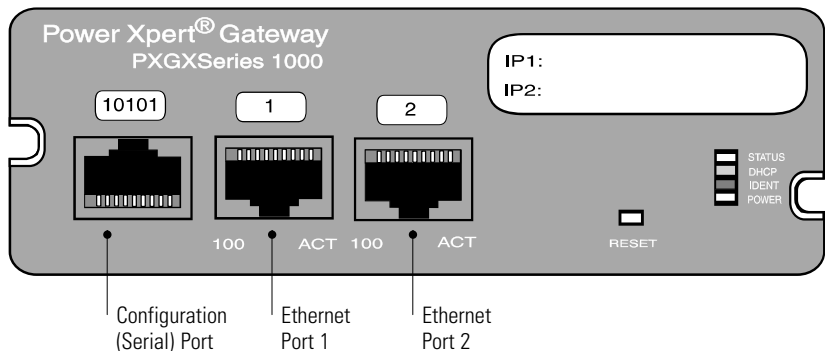

Figure 9. Power Xpert Gateway Series 1000 Card

Chapter 3 Operation

Introduction

The Rack Power Module (RPM-3U/3Ui) distributes output from a UPS or utility power to twelve poles. The poles are grouped into two banks of six poles, with each bank corresponding to an output plate on the back of the RPM-3U/3Ui. Each output plate contains a set of distribution receptacles. The two output plates may be of the same receptacle type or different types.

See “Specifications” on page 33 for a complete list of available output plate receptacle types.

Figure 10 shows an example of a rear panel.

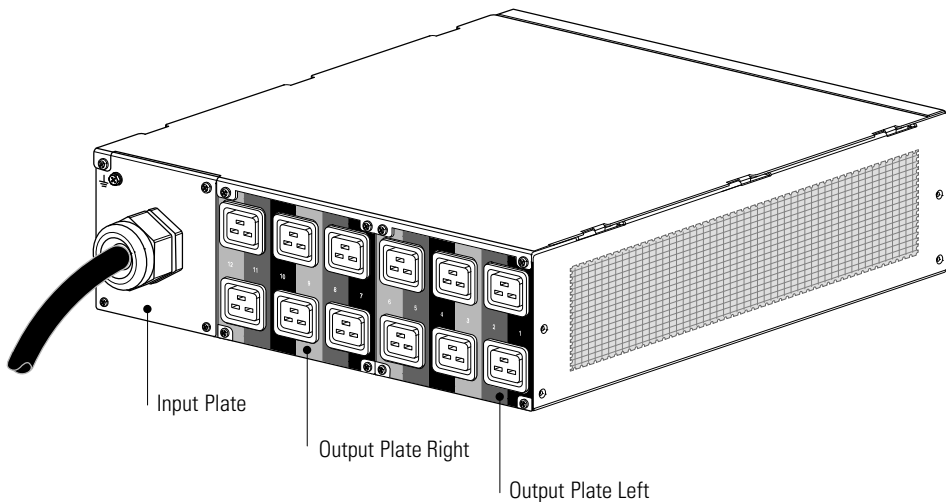

Figure 10. RPM-3U/3Ui Rear Panel [Plug-Receptacle Unit with IEC 320-C19 (208 Vac) Output Plates Shown]

The RPM-3U/3Ui front panel controls the power distribution and communicates its status. Figure 11 shows an example of a front panel.

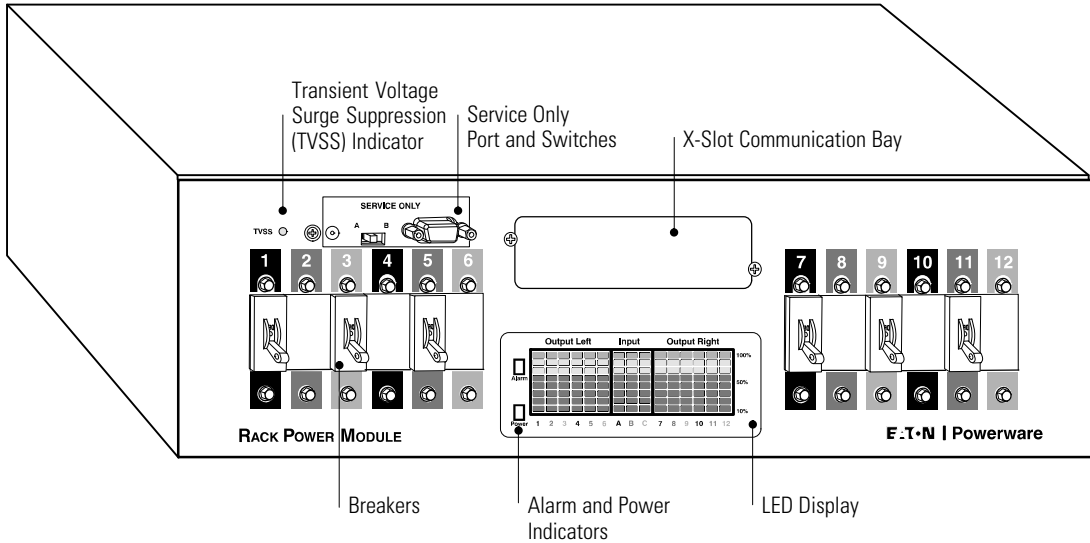

Figure 11. RPM-3U/3Ui Front Panel (Standard 208Y/120V Unit Shown)

Breakers

The breakers on the front panel control the receptacles on the rear panel. Retain the breaker tabs. Use the tabs to prevent accidental tripping of the breakers.



NOTE *If a current overload occurs, the breakers will trip with the breaker tabs in place.*

Color-Coded Numbering

The breakers are labeled 1 through 12, left to right, one label per pole. A three-color repeating pattern makes it easy to quickly identify the associated number on the receptacles on the rear panel (see Figure 10 on page 29). The receptacles are labeled right to left, matching the breakers directly connected to them.

The columns of LEDs in the LED display (see Figure 11) are labeled with numbers and colors that match their breaker/receptacle pairs.

LED Display

The LED display indicates the 0 to 100% load capacity of all 12 poles of breakers and three phases of input current, using a summation of the output currents to indicate the true Root Mean Square (RMS) percentage of current capacity regardless of the circuit rating.

The Output Left LEDs display the load capacity of breaker poles 1–6; the Output Right LEDs display breaker poles 7–12. The Input LEDs display the input current (phases A, B, C for RPM-3U units, or L1, L2, L3 for RPM-3Ui units). See Figure 12 and Figure 13.

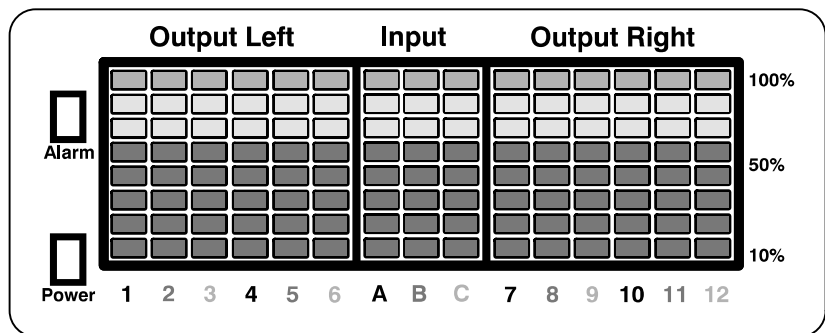

Figure 12. LED Display (RPM-3U Units)

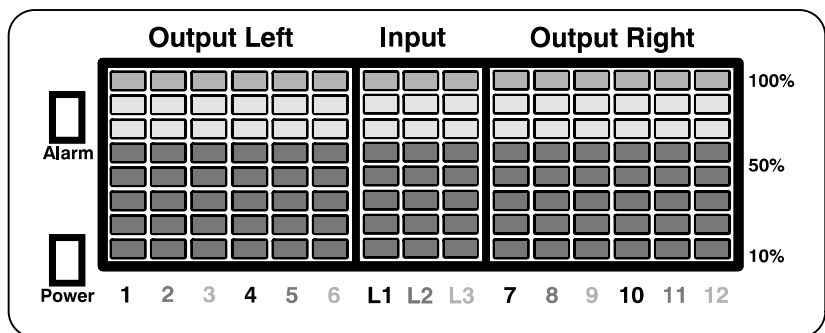

Figure 13. LED Display (RPM-3Ui Units)

The LED display contains 15 columns of eight LEDs each. From the bottom up, the first five LEDs illuminate green, the next two illuminate yellow, and the top LED illuminates red.

The RPM-3U/3Ui senses the continuously varying analog CT currents, samples them, calculates their RMS values, and then illuminates the correct LEDs to indicate load status.

Breaker metering is normalized: the RPM-3U/3Ui scales the display readings based on the type of breaker (15A, 20A, 30A) used on the output and the ratings on the input. If a mix of breaker amperages are connected, then all are normalized to the highest rating.

Alarm and Power Indicators

The RPM-3U/3Ui has two indicators to the left of the LED display:

Indicator	On	Off
Alarm	Alarm Condition (red)	No alarm present
Power*	On Utility (green)	No utility present

* Power to internal metering and display is within acceptable limits.

An alarm sounds an audible buzzer. The alarm resets when the condition is corrected. For more information about alarm conditions, see “Troubleshooting” on page 39.

TVSS Indicator

The 50 kA/phase TVSS feature is optional.

Indicator	Green	Red	Off
TVSS	Active	Fail*	No TVSS present

* TVSS failure sounds an audible buzzer. See “Troubleshooting” on page 39.

Service Only Port and Switches

The DB-9 communication port, A/B switch, and reset switch are service-only features.

Chapter 4 Specifications

This section provides the following specifications for the Rack Power Module (RPM-3U/3Ui):

- Dimensions and weight
- Metering
- Communication options
- Environmental and safety
- Electrical input and output

Table 2. Dimensions and Weight

Dimensions (WxHxD) Units are 3U rack height. NOTE Depth varies depending on installed options.	Plug-Receptacle Units: 44.12 x 13.06 x 50.45 cm (17.4" x 5.14" x 19.9") Hardwired Units: 44.12 x 13.06 x 66.83 cm (17.4" x 5.14" x 26.3") Cable Tray: 44.45 x 12.65 x 17.20 cm (17.5" x 5" x 6.8") Depth of Cable Tray installed is 14.61 cm (5.75").
Weight NOTE Weight varies depending on installed options.	Typical Hardwired Unit: 14.5 kg (32 lb) Typical Plug-Receptacle Unit: 13.6 kg (30 lb) Typical Power Cord: up to 9.1 kg (20 lb) Cable Tray: 0.85 kg (1.9 lb) Wallmount Brackets: 1.0 kg (2.2 lb) Advanced Metering: cards, 1.4 kg (3 lb); external cables, 0.9 kg (2 lb)

Table 3. Metering

LED Display Configuration	15 columns of 8 LEDs each
LED Display Tolerance	± 9%

Table 4. Communication Options

X-Slot Connectors	(1) available X-Slot connector
Compatible X-Slot Cards	Power Xpert Gateway Series 1000 Card Modbus® Card
Serial Port	RS-232 DB-9 (service only)

Table 5. Environmental and Safety

Operating Temperature	0°C to 30°C (32°F to 86°F)
Nonoperating Temperature	-25°C to 70°C (-13°F to 158°F)
Relative Humidity	5–95% noncondensing
Operating Altitude	Up to 3,050 meters (10,006 ft) above sea level with no derating
Nonoperating Altitude	Capable of air transport
Acoustical Noise	<50 dBA
EMI Suppression	FCC 47, part 15, for Class A devices
Electrostatic Discharge (ESD)	IEC 801-2 Up to 25 kV pulse without damage with no adverse effect to critical load
Agency Markings	VDE 0660 Part 101, UL489 208Y/120V only: UL/CSA 60950-1, NOM 400Y/230V only: CE Mark, CB Report, IEC/EN 60950-1, GOST
Seismic	Uniform Building Code (UBC) for Zone 4 Earthquake

Table 6. Electrical Input

Nominal Voltage (Range)	RPM-3U: 208V (176–260V)	RPM-3Ui: 400V (300–460V)
Nominal Frequency (Range)	50/60 Hz (45–65 Hz)	
Input Conductor Configuration	3 wire + N + Gnd	
Input Power Factor	Load dependent	
Input Current THD	Load dependent	

Table 7. Electrical Input Ratings

Model	Input Connection	Input Rating	Derated Input Rating (NFPA/NEC Only)
RPM-3U	Hardwire	96A	96A
	BladeUPS	33.3A	33.3A
	IEC 309-60A	60A	48A
	L21-30	30A	24A
RPM-3Ui	Hardwire	96A	96A
	BladeUPS	33.3A	33.3A

NOTE Input power cords are available in the following length options: 1.8m (6 ft), 3.0m (10 ft), 4.6m (15 ft), 6.1m (20 ft).

Table 8. Output Plate Receptacle Type 5-15R

Receptacle Voltage	Number of Receptacles	Receptacle Phases	Power Connection
120 Vac	6	1	Phase to Neutral
Number of Breakers		Receptacles per Breaker	Breaker Rating
6 single-pole breakers		1	15A / 10,000 AIC

Table 9. Output Plate Receptacle Type 5-20R

Receptacle Voltage	Number of Receptacles	Receptacle Phases	Power Connection
120 Vac	6	1	Phase to Neutral
Number of Breakers		Receptacles per Breaker	Breaker Rating
6 single-pole breakers		1	20A / 10,000 AIC

Table 10. Output Plate Receptacle Type L6-15R

Receptacle Voltage	Number of Receptacles	Receptacle Phases	Power Connection
208 Vac	3	2	Phase to Phase
Number of Breakers		Receptacles per Breaker	Breaker Rating
3 two-pole breakers		1	15A / 5,000 AIC

Table 11. Output Plate Receptacle Type L6-20R

Receptacle Voltage	Number of Receptacles	Receptacle Phases	Power Connection
208 Vac	3	2	Phase to Phase
Number of Breakers		Receptacles per Breaker	Breaker Rating
3 two-pole breakers		1	20A / 5,000 AIC

Table 12. Output Plate Receptacle Type L6-30R

Receptacle Voltage	Number of Receptacles	Receptacle Phases	Power Connection
208 Vac	3	2	Phase to Phase
Number of Breakers		Receptacles per Breaker	Breaker Rating
3 two-pole breakers		1	30A / 5,000 AIC

Table 13. Output Plate Receptacle Type L14-20R

Receptacle Voltage	Number of Receptacles	Receptacle Phases	Power Connection
208 Vac	3	2	Phase/Phase/Neutral
Number of Breakers		Receptacles per Breaker	Breaker Rating
3 two-pole breakers		1	20A / 5,000 AIC

Table 14. Output Plate Receptacle Type L14-30R

Receptacle Voltage	Number of Receptacles	Receptacle Phases	Power Connection
208 Vac	3	2	Phase/Phase/Neutral
Number of Breakers		Receptacles per Breaker	Breaker Rating
3 two-pole breakers		1	30A / 5,000 AIC

Table 15. Output Plate Receptacle Type L15-20R

Receptacle Voltage	Number of Receptacles	Receptacle Phases	Power Connection
208 Vac	2	3	Phase/Phase/Phase/Neutral
Number of Breakers		Receptacles per Breaker	Breaker Rating
2 three-pole breakers		1	20A / 5,000 AIC

Table 16. Output Plate Receptacle Type L15-30R

Receptacle Voltage	Number of Receptacles	Receptacle Phases	Power Connection
208 Vac	2	3	Phase/Phase/Phase/Neutral
Number of Breakers		Receptacles per Breaker	Breaker Rating
2 three-pole breakers		1	30A / 5,000 AIC

Table 17. Output Plate Receptacle Type L21-20R

Receptacle Voltage	Number of Receptacles	Receptacle Phases	Power Connection
208 Vac	2	3	Phase/Phase/Phase/Neutral
Number of Breakers		Receptacles per Breaker	Breaker Rating
2 three-pole breakers		1	20A / 5,000 AIC

Table 18. Output Plate Receptacle Type L21-30R

Receptacle Voltage	Number of Receptacles	Receptacle Phases	Power Connection
208 Vac	2	3	Phase/Phase/Phase/Neutral
Number of Breakers		Receptacles per Breaker	Breaker Rating
2 three-pole breakers		1	30A / 5,000 AIC

Table 19. Output Plate Receptacle Type IEC 320-C13 (208Y/120V)

Receptacle Voltage	Number of Receptacles	Receptacle Phases	Power Connection
208 Vac	12	2	Phase to Phase
Number of Breakers		Receptacles per Breaker	Breaker Rating
3 two-pole breakers		4	20A / 5,000 AIC

Table 20. Output Plate Receptacle Type IEC 320-C13 (400Y/230V)

Receptacle Voltage	Number of Receptacles	Receptacle Phases	Power Connection
230 Vac	12	1	Phase to Neutral
Number of Breakers		Receptacles per Breaker	Breaker Rating
6 single-pole breakers		2	10A / 5,000 AIC

Table 21. Output Plate Receptacle Type IEC 320-C19 (208Y/120V)

Receptacle Voltage	Number of Receptacles	Receptacle Phases	Power Connection
208 Vac	6	2	Phase to Phase
Number of Breakers		Receptacles per Breaker	Breaker Rating
3 two-pole breakers		2	20A / 5,000 AIC

Table 22. Output Plate Receptacle Type IEC 320-C19 (400Y/230V)

Receptacle Voltage	Number of Receptacles	Receptacle Phases	Power Connection
230 Vac	6	1	Phase to Neutral
Number of Breakers		Receptacles per Breaker	Breaker Rating
6 single-pole breakers		1	16A / 5,000 AIC

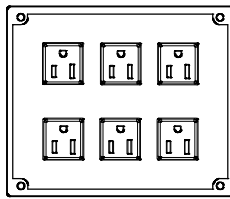

5-15R

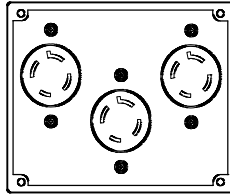

L14-20R

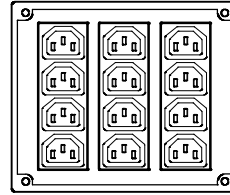

IEC 320-C13 (208Y/120V)

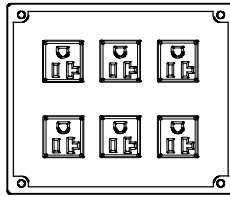

5-20R

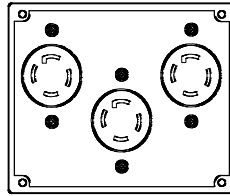

L14-30R

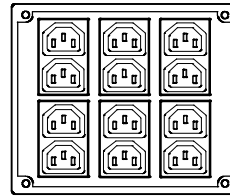

IEC 320-C13 (400Y/230V)

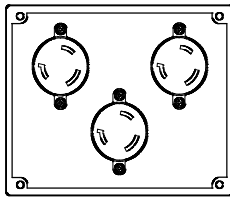

L6-15R

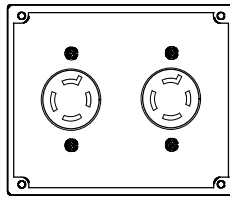

L15-20R

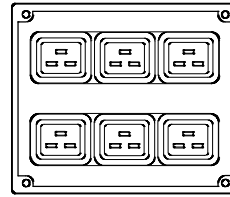

IEC 320-C19 (208Y/120V)

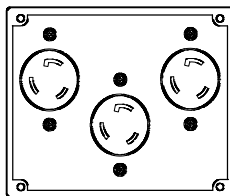

L6-20R

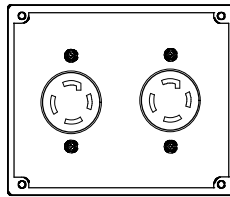

L15-30R

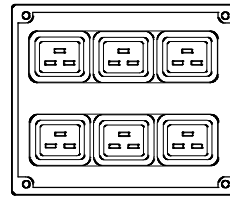

IEC 320-C19 (400Y/230V)

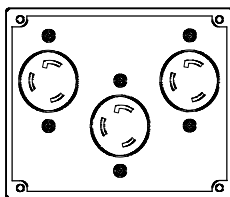

L6-30R

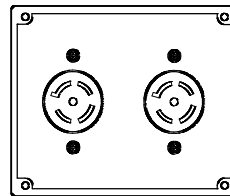

L21-20R

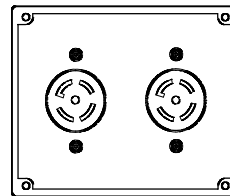

L21-30R

Figure 14. Output Receptacle Types

Chapter 5 Troubleshooting

The Rack Power Module (RPM-3U/3Ui) is designed for durable, automatic operation and also alerts you whenever potential operating problems may occur. Usually the alarms shown on the front panel do not mean that the output power is affected. Instead, they are preventive alarms intended to alert the user.

Typical Alarms and Conditions

“Operation” on page 29 describes the indicators on the front panel.

The following table describes typical alarms and conditions. For further help, please contact the Help Desk.

Alarm or Condition	Possible Cause	Action
Alarm indicator is illuminated.	Overload condition.	Remove some of the equipment from the RPM-3U/3Ui.
Alarm and Power indicators are illuminated. The TVSS indicator (if TVSS is installed) is red.	One phase is dropped, or the TVSS has failed.	If the condition persists, contact your service representative.

Service and Support

If you have any questions or problems with the RPM-3U/3Ui, call your **Local Distributor** or the **Help Desk** at one of the following telephone numbers and ask for an RPM-3U/3Ui technical representative:

United States: **1-800-356-5737** or **1-919-870-3149**

Canada: **1-800-461-9166 ext 260**

All other countries: **Call your local service representative**

Please have the following information ready when you call for service:

- Model number
- Serial number
- Date of failure or problem
- Symptoms of failure or problem
- Customer return address and contact information

Chapter 6 Warranty

Limited Factory Warranty

Three-Phase Eaton Power Distribution Unit (PDU) and Static Switch (STS) Products

WARRANTOR: The warrantor for the limited warranties set forth herein is Eaton Corporation, an Ohio Corporation ("Eaton").

LIMITED WARRANTY: This limited warranty (this "Warranty") applies only to the original end-user (the "End-User") of the Eaton Three-Phase PDU and STS Products (the "Product") and cannot be transferred. This Warranty applies even in the event that the Product is initially sold by Eaton for resale to an End-User. **This warranty is not valid unless a separately purchased Startup service is purchased.**

LIMITED WARRANTY PERIOD: The period covered by this Warranty for Product installed [and currently located] in the fifty (50) United States and the District of Columbia is twelve (12) months from the date of Product startup or eighteen (18) months from the date of Product shipment, whichever occurs first, for parts coverage and 90 days from the date of Product startup for labor coverage. The period covered by this Warranty for Product installed [and currently located] outside of the fifty (50) United States and the District of Columbia is twelve (12) months from the date of Product startup or eighteen (18) months from the date of Product shipment, whichever occurs first, for parts coverage.

WHAT THIS LIMITED WARRANTY COVERS: The warrantor warrants that the Eaton three-phase PDU and STS electronics and Eaton-provided accessories (individually and collectively, the "Warranted Items") are free from defects in material and workmanship. If, in the opinion of Eaton, a Warranted Item is defective and the defect is within the terms of this Warranty, Eaton's sole obligation will be to repair or replace such defective item (including by providing service, parts, and labor, as applicable), at the option of Eaton. The Warranted Item will be repaired or replaced onsite at the End-User's location or such other location as determined by Eaton. Any parts that are replaced may be new or reconditioned. All parts replaced by Eaton shall become the property of Eaton.

WHAT THIS LIMITED WARRANTY DOES NOT COVER: This Warranty does not cover any defects or damages caused by: (a) failure to properly store the Product before installation; (b) shipping and delivery of the Product if shipping is FOB Factory; (c) neglect, accident, fire, flood, lightning, vandalism, acts of God, Customer's neglect, abuse, misuse, misapplication, incorrect installation; (d) repair or alteration not authorized in writing by Eaton personnel or performed by an authorized Eaton Customer Service Engineer or Agent; or (e) improper testing, operation, maintenance, adjustment, or any modification of any kind not authorized in writing by Eaton personnel or performed by an authorized Eaton Customer Service Engineer or Agent.

This Warranty is not valid: (a) unless an authorized Eaton Customer Service Engineer (in the USA) or Agent (outside of the USA) performs startup and commissioning of the Product; (b) if the Product is moved to a new location by someone other than an authorized Eaton Customer Service Engineer (in the USA) or Agent (outside of the USA); or (c) if the Product's serial numbers have been removed or are illegible. Any Warranted Items repaired or replaced pursuant to this Warranty will be warranted for the remaining portion of the original Warranty subject to all the terms thereof. Labor warranty is not provided for Product located outside of the fifty (50) United States or the District of Columbia. **Any equipment, parts, or materials included in the Product and not manufactured by Eaton are warranted solely by the manufacturer of such equipment, parts, or materials and are not included as part of this Warranty.**

WARRANTY

THIS WARRANTY IS THE END-USER'S SOLE REMEDY AND IS EXPRESSLY IN LIEU OF, AND THERE ARE NO OTHER EXPRESSED OR IMPLIED GUARANTEES OR WARRANTIES (INCLUDING ANY IMPLIED WARRANTY OF MERCHANTABILITY OR FITNESS FOR ANY PURPOSE, WHICH ARE EXPRESSLY DISCLAIMED).

LIMITATION OF LIABILITY: In no event shall Eaton be liable for any indirect, incidental, special, or consequential damages of any kind or type whatsoever, or based on any claim or cause of action, however denominated. Eaton shall not be responsible for failure to provide service or parts due to causes beyond Eaton's reasonable control. In no case will Eaton's liability under this Warranty exceed the replacement value of the Warranted Items.

END-USER'S OBLIGATIONS: In order to receive the benefits of this Warranty, the End-User must use the Product in a normal way, follow the Product's user's guide, and protect against further damage to the Product if there is a covered defect.

OTHER LIMITATIONS: Eaton's obligations under this Warranty are expressly conditioned upon receipt by Eaton of all payments due to it (including interest charges, if any). During such time as Eaton has not received payment of any amount due to it for the Product, in accordance with the contract terms under which the Product is sold, Eaton shall have no obligation under this Warranty. Also during such time, the period of this Warranty shall continue to run and the expiration of this Warranty shall not be extended upon payment of any overdue or unpaid amounts.

COSTS NOT RELATED TO WARRANTY: The End-User shall be invoiced for, and shall pay for, all services not expressly provided for by the terms of this Warranty, including without limitation site calls involving an inspection that determines no corrective maintenance is required. Any costs for replacement equipment, installation, materials, freight charges, travel expenses, or labor of Eaton representatives outside the terms of this Warranty will be borne by the End-User.

OBTAINING WARRANTY SERVICE: In the USA, call the Eaton Customer Reliability Center 7x24 at 800-843-9433. Outside of the USA, contact your local Eaton sales or service representative. For comments or questions about this Limited Factory Warranty, write to the Customer Quality Representative, 3301 Spring Forest Road, Raleigh, North Carolina 27616 USA.



164201675 2